

# BAR STOCK THERMOWELLS WITH WELDED CONNECTION MODEL : A630, A631, A632



## ORDERING INFORMATION

### BASE MODEL - 1st thru 4th characters

A630 : Straight Bar Stock (Welded Connection Type)  
A631 : Tapered Bar Stock (Welded Connection Type)  
A632 : Stepped Bar Stock (Welded Connection Type)

### 15th Character-Options

0=None  
1=Plug & Chain

### 5th Character- Extension

0= None 1= Extension

Note (\*)Not Available for A601 & A602

### 6th & 7th Characters - Material of Well

AX:S25C	BX:304SS	CX:316SS	DX:304LSS
EX:316LSS	FX:310SS	GX:321SS	HX:446SS
IX:A182F304	JX:Inconel	KX:Hast-C	LX:Monel
MX:Titanium	OX:A182F316	TX:Incoloy	UX:A182F22
VX:A182F91	WX:A105	XX:A182F321	YX:A182-F11
ZX:Others			

### 8th Character- Internal Connection

0=1/2" NPT  
1=1/2" PT  
2=1/2" PF

### 9th & 10th Characters- End Out Dia./Bore Size

A0=14/7	A1=14/9	B0=16/7	B1=16/9	B2=16/10
C0=17/7	C1=17/9	C2=17/10	C3=17/12	D0=19/7
D1=19/9	D2=19/10	D3=19/12	A4=21/10	

### 11th Character- Connection Size

AZ=1/2" BZ=3/4" CZ=1" DZ=1 1/4" EZ=1 1/2"

### 13th Character- Insertion Length ("U"-Length)

0=80	1=100	2=150	3=200	4=250	5=300
6=350	7=400	8=450	A=500	B=600	C=700
D=800	E=900	F=1000	Z=Others		

Note (\*) please choose code of next higher length if application length is not.  
Actual length shall be specified

### 14th Character-Extension Length ("T"-Length)

0=None(MFR.STD) 1=Bleow 50MM 2=More than 50MM  
9=Others

Note Actual length shall be specified.

## A6310BXOBOBZ400 SAMPLE ORDERING NUMBER

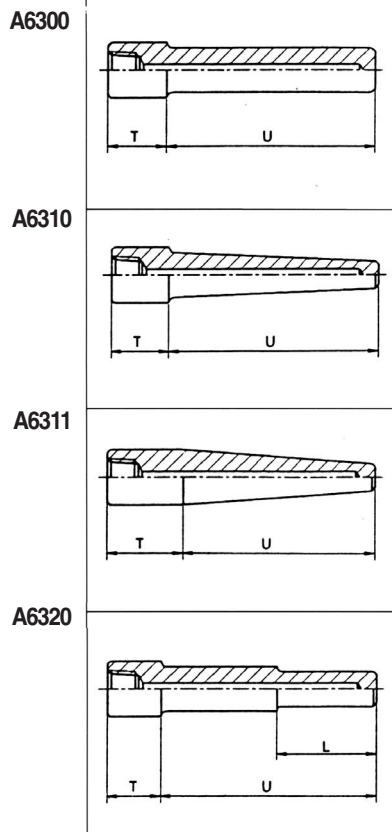

# THERMOWELLS

THERMOWELL

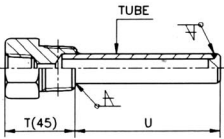
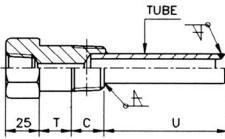
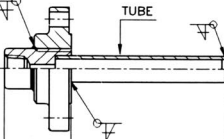
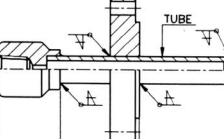
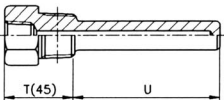
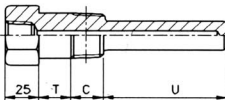
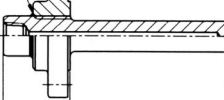
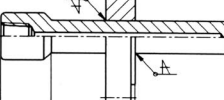
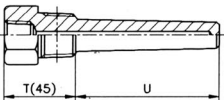
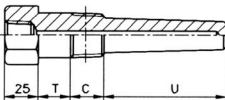
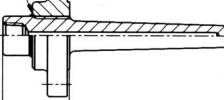
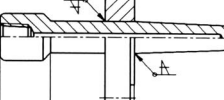
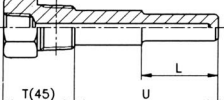
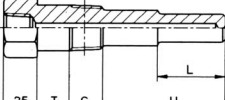
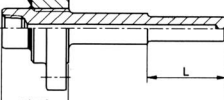
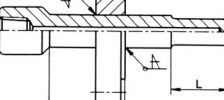
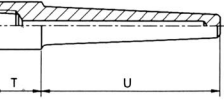
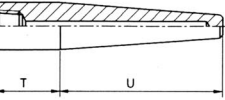
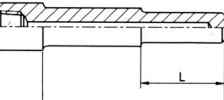
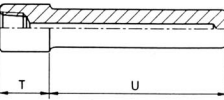
	THREAD TYPE		FLANGE TYPE	
	PLANE TYPE	LAG TYPE	PLANE TYPE	LAG TYPE
CLOSED END TUBE STRAIGHT TYPE				
	A5000	A5001	A5100	A5101
DRILLED BAR STOCK STRAIGHT TYPE				
	A6000	A6001	A6100	A6101
DRILLED BAR STOCK TAPER TYPE				
	A6010	A6011	A6110	A6111
DRILLED BAR STOCK STEP TYPE				
	A6020	A6021	A6120	A6121
DRILLED BAR STOCK WELD TYPE	WELD-IN TYPE		SOCKET WELD TYPE	
				
	A6310	A6311	A6320	A6300